

**Superseded by a more recent version**



INTERNATIONAL TELECOMMUNICATION UNION

**ITU-T**

TELECOMMUNICATION  
STANDARDIZATION SECTOR  
OF ITU

**H.324**

(03/96)

**SERIES H: TRANSMISSION OF NON-TELEPHONE  
SIGNALS**

Infrastructure of audiovisual services - Systems and  
terminal equipment for audiovisual services

---

**Terminal for low bit rate Multimedia  
Communication**

ITU-T Recommendation H.324

(Previously "CCITT Recommendation")

---

# Superseded by a more recent version

## FOREWORD

The ITU-T (Telecommunication Standardization Sector) is a permanent organ of the International Telecommunication Union (ITU). The ITU-T is responsible for studying technical, operating and tariff questions and issuing Recommendations on them with a view to standardizing telecommunications on a worldwide basis.

The World Telecommunication Standardization Conference (WTSC), which meets every four years, establishes the topics for study by the ITU-T Study Groups which, in their turn, produce Recommendations on these topics.

The approval of Recommendations by the Members of the ITU-T is covered by the procedure laid down in WTSC Resolution No. 1 (Helsinki, March 1-12, 1993).

ITU-T Recommendation H.324 was prepared by ITU-T Study Group 15 (1993-1996) and was approved under the WTSC Resolution No. 1 procedure on the 19th of March 1996.

---

## NOTE

In this Recommendation, the expression "Administration" is used for conciseness to indicate both a telecommunication administration and a recognized operating agency.

© ITU 1996

All rights reserved. No part of this publication may be reproduced or utilized in any form or by any means, electronic or mechanical, including photocopying and microfilm, without permission in writing from the ITU.

# Superseded by a more recent version

## CONTENTS

	<i>Page</i>	
1	Scope.....	1
1.1	Block diagram and functional elements.....	1
1.2	System elements outside the scope of Recommendation H.324.....	2
1.3	Functional elements covered by Recommendation H.324.....	2
2	References.....	3
3	Definitions.....	4
4	Abbreviations.....	5
5	Conventions.....	5
6	Functional requirements.....	5
6.1	Required elements.....	5
6.2	Information streams.....	6
6.3	Modem.....	6
6.4	Multiplex.....	6
6.5	Control channel.....	7
6.6	Video channels.....	10
6.7	Audio channels.....	12
6.8	Data channels.....	13
7	Terminal procedures.....	17
7.1	Phase A – call setup of voiceband channel.....	17
7.2	Phase B – initial analogue telephony communication.....	17
7.3	Phase C – establishment of digital communication, modem training.....	18
7.4	Phase D – initialization.....	18
7.5	Phase E – communication.....	19
7.6	Phase F – end of session.....	19
7.7	Phase G – supplementary services and call clearing.....	20
8	Interoperation with other terminals.....	20
8.1	Speech only terminals.....	20
8.2	H.320 multimedia telephone terminals over the ISDN.....	20
8.3	Multimedia telephone terminals over mobile radio.....	20
9	Optional enhancements.....	20
9.1	Data facilities.....	20
9.2	Encryption.....	21
9.3	Multilink.....	22
10	Multipoint considerations.....	22
10.1	Establishment of common mode.....	22
10.2	Multipoint rate matching.....	23
10.3	Multipoint lip synchronization.....	23
10.4	Multipoint encryption.....	23
10.5	Cascaded MCU operation.....	23
11	Maintenance.....	23
11.1	Loopbacks for maintenance purposes.....	23
Annex A	– Protocol stack for control channel.....	26
A.1	General.....	26
A.2	SRP mode.....	27
A.3	LAPM/V.42 mode.....	28

# Superseded by a more recent version

*Page*

Annex B – HDLC frame structure transparency for asynchronous transmission.....	29
Appendix I – Bit and octet order .....	30
Appendix II – V.8 <i>bis</i> codepoints .....	31
Bibliography .....	32

# Superseded by a more recent version

## SUMMARY

This Recommendation describes terminals for low bit rate multimedia communication, utilizing V.34 modems operating over the GSTN. H.324 terminals may carry real-time voice, data, and video, or any combination, including videotelephony.

H.324 terminals may be integrated into personal computers or implemented in stand-alone devices such as videotelephones. Support for each media type (voice, data, video) is optional, but if supported, the ability to use a specified common mode of operation is required, so that all terminals supporting that media type can interwork. This Recommendation allows more than one channel of each type to be in use. Other Recommendations in the H.324-Series include the H.223 multiplex, H.245 control, H.263 video codec, and G.723.1 audio codec.

This Recommendation makes use of the logical channel signalling procedures of Recommendation H.245, in which the content of each logical channel is described when the channel is opened. Procedures are provided for expression of receiver and transmitter capabilities, so transmissions are limited to what receivers can decode, and so that receivers may request a particular desired mode from transmitters. Since the procedures of Recommendation H.245 are also planned for use by Recommendation H.310 for ATM networks, and Recommendation H.323 for non-guaranteed bandwidth LANs, interworking with these systems should be straightforward.

H.324 terminals may be used in multipoint configurations through MCUs, and may interwork with H.320 terminals on the ISDN, as well as with terminals on wireless networks.



# Superseded by a more recent version

Recommendation H.324

## TERMINAL FOR LOW BIT RATE MULTIMEDIA COMMUNICATION

(Geneva, 1996)

### 1 Scope

This Recommendation covers the technical requirements for very low bit rate multimedia telephone terminals operating over the General Switched Telephone Network (GSTN).

H.324 terminals provide real-time video, audio, or data, or any combination, between two multimedia telephone terminals over a GSTN voiceband network connection. Communication may be either 1-way or 2-way. Multipoint communication using a separate MCU among more than two H.324 terminals is possible. MCUs and other non-terminal devices are not bound by the requirements in this Recommendation, but they should comply where practical.

The multimedia telephone terminals defined in this Recommendation can be integrated into PCs or workstations, or be stand-alone units.

Interworking with visual telephone systems on the ISDN (known as the H.320-Series of Recommendations) and on mobile radio networks (known as the H.324/M-Series Recommendations) are also covered.

#### 1.1 Block diagram and functional elements

A generic H.324 multimedia videophone system is shown in Figure 1. It consists of terminal equipment, GSTN modem, GSTN network, Multipoint Control Unit (MCU) and other system operation entities. H.324 implementations are not required to have each functional element.

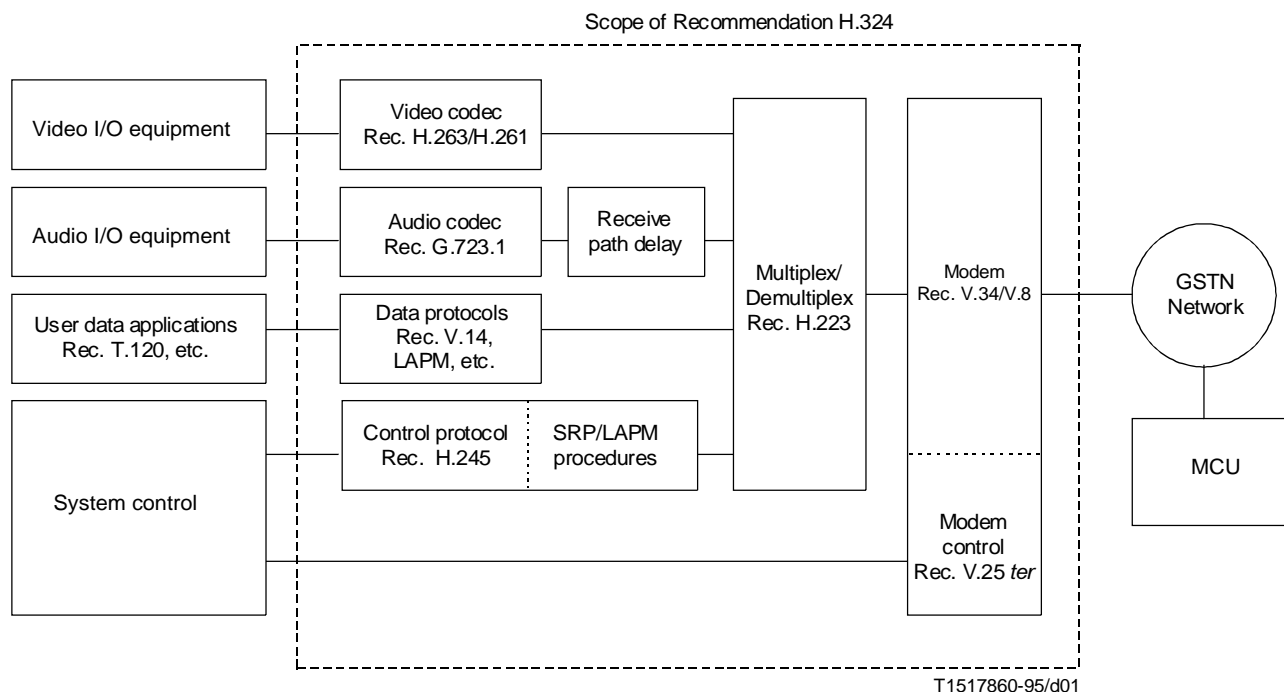

FIGURE 1/H.324  
Block diagram for H.324 multimedia system

# Superseded by a more recent version

## 1.2 System elements outside the scope of Recommendation H.324

The following system elements are covered by other Recommendations or are not subject to standardization, and are therefore not defined in this Recommendation:

- Video I/O equipment including cameras and monitors, their control and selection, video processing to improve compression or provide split-screen functions.
- Audio I/O equipment including microphone and loudspeaker, telephone instrument or equivalent, attached audio devices providing voice activation sensing, multiple microphone mixers, acoustic echo cancellation.
- Data application equipment such as computers, non-standardized data application protocols, telematic visual aids such as electronic whiteboards, etc.
- GSTN network interface supporting appropriate signalling, ringing functions and voltage levels, in accordance with national standards.
- Human user system control, user interface and operation.

## 1.3 Functional elements covered by Recommendation H.324

The scope of this Recommendation is indicated by the elements within the dashed line of Figure 1, which include:

- The Video Codec (H.263 or H.261) carries out redundancy reduction coding and decoding for video streams.
- The Audio Codec (G.723.1) encodes the audio signal from the microphone for transmission, and decodes the audio code which is output to the speaker. Optional delay in the receiving audio path compensates for the video delay, so as to maintain audio and video synchronization.
- The Data Protocols support data applications such as electronic whiteboards, still image transfer, file exchange, database access, audiographics conferencing, remote device control, network protocols, etc. Standardized data applications include T120 for real-time audiographics conferencing, T84 simple point-point still image file transfer, T434 simple point-point file transfer, H.224/H.281 far-end camera control, ISO/IEC TR9577 network protocols including PPP and IP, and transport of user data using buffered V.14 or LAPM/V.42. Other applications and protocols may also be used via H.245 negotiation.
- The Control Protocol (H.245) provides end-to-end signalling for proper operation of the H.324 terminal, and signals all other end-to-end system functions including reversion to analogue speech-only telephony mode. It provides for capability exchange, signalling of commands and indications, and messages to open and fully describe the content of logical channels.
- The Multiplex Protocol (H.223) multiplexes transmitted video, audio, data and control streams into a single bit stream, and demultiplexes a received bit stream into various multimedia streams. In addition, it performs logical framing, sequence numbering, error detection, and error correction by means of retransmission, as appropriate to each media type.
- The Modem (V.34) converts the H.223 synchronous multiplexed bit stream into an analogue signal that can be transmitted over the GSTN, and converts the received analogue signal into a synchronous bit stream that is sent to the Multiplex/Demultiplex protocol unit. Recommendation V.25 *ter* is used to provide control/sensing of the modem/network interface, when the modem with network signalling and V.8/V.8 *bis* functional elements is a separate physical item.



# Superseded by a more recent version

## 2 References

The following Recommendations and other references contain provisions which, through reference in this text, constitute provisions of this Recommendation. At the time of publication, the editions indicated were valid. All Recommendations and other references are subject to revision; all users of this Recommendation are therefore encouraged to investigate the possibility of applying the most recent edition of the Recommendations and other references listed below. A list of the currently valid ITU-T Recommendations is regularly published.

- [1] ITU-T Recommendation H.223 (1996), *Multiplexing protocol for low bitrate multimedia communication.*
- [2] ITU-T Recommendation H.245 (1996), *Control protocol for multimedia communication.*
- [3] ITU-T Recommendation G.723.1 (1996), *Dual rate speech coder for multimedia communications transmitting at 5.3 and 6.3 kbit/s.*
- [4] ITU-T Recommendation H.263 (1996), *Video coding for low bit rate communication.*
- [5] ITU-T Recommendation H.261 (1993), *Video codec for audiovisual services at p 64 kbit/s.*
- [6] ITU-T Recommendation H.320 (1996), *Narrow-band visual telephone systems and terminal equipment.*
- [7] ITU-T Recommendation H.233 (1995), *Confidentiality system for audiovisual services.*
- [8] ITU-T Recommendation H.234 (1994), *Encryption key management and authentication system for audiovisual services.*
- [9] ITU-T Recommendation H.224 (1994), *A real time control protocol for simplex applications using the H.221 LSD/HSD/MLP channels.*
- [10] ITU-T Recommendation H.281 (1994), *A far end camera control protocol for video conferences using H.224.*
- [11] ITU-T Recommendation V.8 (1994), *Procedures for starting sessions of data transmission over the General switched telephone network.*
- [12] ITU-T Recommendation V.8 bis<sup>1)</sup>, *Procedures for the identification and selection of common modes of operation between DCEs and between DTEs over the general switched telephone network and on leased point-to-point telephone-type circuits.*
- [13] ITU-T Recommendation V.14 (1993), *Transmission of start-stop characters over synchronous bearer channels.*
- [14] ITU-T Recommendation V.25 ter (1995), *Serial asynchronous automatic dialling and control.*
- [15] ITU-T Recommendation V.42 (1993), *Error-correcting procedures for DCEs using asynchronous-to-synchronous conversion.*
- [16] ITU-T Recommendation V.42 bis (1990), *Data compression procedures for Data Circuit terminating Equipment (DCE) using error correction procedures.*
- [17] ITU-T Recommendation V.34 (1994), *A modem operating at data signalling rates of up to 28 800 bit/s for use on the General switched telephone network and on leased point-to-point 2-wire telephone-type circuits.*
- [18] ITU-T T.84 | ISO/IEC 10918-3<sup>1)</sup>, *Information technology – Digital compression and coding of continuous tone still Images – Extensions.*
- [19] ITU-T Recommendation T.120 (1996), *Data protocols for multimedia conferencing.*
- [20] CCITT Recommendation T.434 (1992), *Binary file transfer format for the telematic services.*
- [21] ISO/IEC 3309:1993, *Information Technology – Telecommunications and information exchange between systems – High-level data link control (HDLC) procedures – Frame structure.*

---

<sup>1)</sup> Presently at stage of draft.

# Superseded by a more recent version

- [22] CCITT Recommendation G.711 (1988), *Pulse Code Modulation (PCM) of voice frequencies*.
- [23] ITU-T Recommendation H.221 (1993), *Frame structure for a 64 to 1920 kbit/s channel in audiovisual teleservices*.
- [24] ITU-T Recommendation X.691 (1995), *Information technology – ASN.1 encoding rules: Specification of Packed Encoding Rules (PER)*.
- [25] ISO/IEC TR 9577:1993, *Information technology – Telecommunications and information exchange between systems – protocol identification in the network layer*.

## 3 Definitions

For the purposes of this Recommendation the definitions given in clause 3 of both Recommendations H.223 and H.245 apply along with the following.

- 3.1 AL-SDU:** The logical unit of information exchanged between the H.223 multiplex and the audio codec, video codec, or data protocol above.
- 3.2 channel:** A unidirectional link between two end-points.
- 3.3 codec:** Coder/decoder, used to convert audio or video signals to/from digital format.
- 3.4 connection:** A bi-directional link between two end-points.
- 3.5 control channel:** Dedicated logical channel number 0 carrying system control protocol per Recommendation H.245.
- 3.6 data:** Information streams other than control, audio and video, carried in a logical data channel (see Recommendation H.223).
- 3.7 in-band signalling:** Control signals sent within a specific logical channel other than the control channel, carrying information applicable only to that logical channel.
- 3.8 interworking adapter:** A device connected to terminals or MCUs working according to two or more Recommendations, which translates the content of one or more logical channels to allow interoperation between otherwise incompatible equipment.
- 3.9 lip synchronization:** Operation to provide the feeling that speaking motion of the displayed person is synchronized with the voice sounds.
- 3.10 logical channel:** One of several logically distinct channels carried over a single bit stream.
- 3.11 media:** One or more of audio, video, or data.
- 3.12 multilink:** The use of more than one physical connection to obtain a larger aggregate bit rate.
- 3.13 multipoint:** The simultaneous interconnection of three or more terminals to allow communication among several sites through the use of multipoint control units (bridges) which centrally direct the flow of information.
- 3.14 MUX-PDU:** The logical unit of information exchanged between the H.223 multiplex layer and the underlying physical layer. It is a packet framed by HDLC flags and using HDLC zero-bit insertion for transparency.
- 3.15 non-segmentable:** The H.223 mode of operation in which AL-SDUs must be sent as consecutive octets in a single MUX-PDU. See Recommendation H.223.
- 3.16 segmentable:** The H.223 mode of operation in which AL-SDUs may be sent in separate multiplex slots carried on one or more MUX-PDUs. See Recommendation H.223.
- 3.17 support:** The ability to operate in a given mode, however a requirement to “support” a mode does not mean that the mode must actually be used at all times. Unless prohibited, other modes may be used by mutual negotiation.
- 3.18 videophone:** A terminal capable of sending and receiving audio and video information simultaneously.

# Superseded by a more recent version

## 4 Abbreviations

For the purposes of this Recommendation, the following symbols and abbreviations apply.

AL-SDU	Adaptation Layer Service Data Unit (see H.223)
CIF	Common Intermediate Format
CRC	Cyclic Redundancy Check
DCE	Data Communication Equipment
DTE	Data Terminal Equipment
EIV	Encryption Initialization Vector
GSTN	General Switched Telephone Network
HDLC	High-level Data Link Control, per ISO/IEC 3309
ISDN	Integrated Services Digital Network
ITU-T	International Telecommunication Union – Telecommunication Standardization Sector
LAPM	Link Access Procedure for Modems (per Recommendation V.42)
LCN	Logical Channel Number (per Recommendation H.223)
MCU	Multipoint Control Unit
NLPID	Network Layer Protocol Identifier (per ISO/IEC TR 9577)
QCIF	Quarter CIF
SE	Session Exchange (per Recommendation H.233)
SQCIF	Sub QCIF
SRP	Simple Retransmission Protocol (see Annex A)

## 5 Conventions

The word “shall” is used in this Recommendation to specify a mandatory requirement.

The word “should” is used in this Recommendation to specify a suggested, but not required, course of action.

The word “may” is used in this Recommendation to specify an optional course of action, without expressing a preference.

References in this Recommendation to specific H.245 ASN.1 message structures are presented in **this typeface**.

## 6 Functional requirements

### 6.1 Required elements

H.324 implementations are not required to have each functional element, except for the V.34 modem, H.223 multiplex, and H.245 system control protocol all of which shall be supported by all H.324 terminals.

H.324 terminals offering audio communication shall support the G.723.1 audio codec. H.324 terminals offering video communication shall support the H.263 and H.261 video codecs. H.324 terminals offering real-time audiographic conferencing should support the T.120 protocol suite. In addition, other video and audio codecs, and other data protocols, may optionally be used via negotiation over the H.245 control channel.

If a modem external to the H.324 terminal is used, terminal/modem control shall conform to Recommendation V.25 *ter*.

# Superseded by a more recent version

The presence of optional facilities is signalled via the H.245 control channel. If both ends support an optional facility, and choose to make use of it, the opening of a path to carry such information streams is negotiated according to the procedures of Recommendation H.245.

NOTE – This Recommendation does not specify a particular implementation. Any implementation that provides the required functionality, and that conforms to the bit stream format ultimately described by this Recommendation, is considered compliant.

## 6.2 Information streams

Multimedia information streams are classified into video, audio, data, and control as follows:

- Video streams are continuous traffic carrying moving colour pictures. When used, the bit rate available for video streams may vary according to the needs of the audio and data channels.
- Audio streams are real-time, but may optionally be delayed in the receiver processing path to maintain synchronization with the video streams. In order to reduce the average bit rate of audio streams, voice activation may be provided.
- Data streams may represent still pictures, facsimile, documents, computer files, computer application data, undefined user data, and other data streams.
- Control streams pass control commands and indications between remote counterparts. Terminal-to-modem control conforms to Recommendation V.25 *ter* for terminals using external modems connected by a separate physical interface. Terminal-to-terminal control is according to Recommendation H.245.

## 6.3 Modem

Modems used for H.324 terminals shall operate in full duplex, synchronous mode and conform to Recommendation V.34 and Recommendation V.8. Support of Recommendation V.8 *bis* is optional. The output of the H.223 multiplex shall be applied directly to the V.34 synchronous data pump. When an external, non-integrated V.34 modem is used, control between the modem and the terminal shall be via Recommendation V.25 *ter*. In such cases the physical interface is implementation specific.

The use of the optional V.34 auxiliary channel is reserved for further study.

## 6.4 Multiplex

Logical channels of video, audio, data or control information may be transmitted, after the channels have been established according to the procedures of Recommendation H.245. Logical channels are unidirectional, and are independent in each direction of transmission. Any number of logical channels of each media type may be transmitted, except for the H.245 control channel of which there shall be one. The multiplex method used to transmit these logical channels shall conform to Recommendation H.223. The optional exclusive-OR procedure of 6.4.2/H.223 shall not be used by H.324 terminals.

The H.223 multiplex consists of a multiplex layer, which mixes the various logical channels into a single bit stream, and an adaptation layer, which handles error control and sequence numbering, as appropriate to each information stream. The multiplex layer transfers logical channel information in packets called MUX-PDUs, delimited by HDLC flags and using HDLC zero-bit insertion for transparency. Each MUX-PDU contains a one-octet header followed by a variable number of information field octets. The header octet includes a multiplex code, which specifies, by reference to a multiplex table, the mapping of the information field octets to various logical channels. Each MUX-PDU may contain a different multiplex code, and therefore a different mix of logical channels.

H.324 terminals shall signal their H.223 capabilities via the H.245 **H223Capability** message.

### 6.4.1 Logical channel numbers

Each logical channel is identified by a Logical Channel Number (LCN), in the range 0 to 65535, which serves only to associate logical channels with the corresponding entries in the H.223 multiplex table. Logical channel numbers are selected arbitrarily by the transmitter, except that logical channel 0 shall be permanently assigned to the H.245 control channel.

# Superseded by a more recent version

## 6.4.2 Multiplex table entries

Multiplex table entries are independent in each direction of transmission, and are sent from transmitters to receivers using the H.245 **MultiplexEntrySend** request message. Multiplex table entry 0 shall not be sent, but shall be permanently assigned to logical channel 0, used for the control channel. Multiplex table entry 0 shall therefore be used for initial capability exchanges and transmission of initial multiplex table entries.

## 6.4.3 Flow control

H.324 terminals shall respond to the **FlowControlCommand** message of H.245, which commands a limit to the overall bit rate of one or more logical channels, or the entire multiplex.

When one or more logical channels are limited by the **FlowControlCommand**, other less restricted logical channels may increase their transmission rate. The limit applies to the content of the logical channel at the input to the multiplex layer, before flags or zero-bit insertion is applied.

When the entire H.223 multiplex is limited by the **FlowControlCommand**, or when the terminal has no information to send, the terminal shall send HDLC flags in place of logical channel information. The limit applies to the entire multiplex output, including opening flags, header octets, and inserted zero bits, but not including idle flags.

## 6.4.4 Error control

The multiplex layer of Recommendation H.223 does not perform error control, except for a CRC on the header octet. Error control for each logical channel is handled separately by the adaptation layers of H.223, which may use a variety of error control techniques, including but not limited to error detection and retransmission.

## 6.4.5 Adaptation layers

Recommendation H.223 defines three adaptation layers, AL1, AL2, and AL3. AL1 is intended primarily for variable-rate framed information, including unframed octets treated as a single frame of indefinite length. AL2 is intended primarily for digital audio, and includes an 8-bit CRC and optional sequence numbers. AL3 is intended primarily for digital video and includes provision for retransmission.

The logical unit of information exchanged between the H.223 multiplex and the audio codec, video codec, data protocol, or control protocol above is called an AL-SDU.

Logical channels carried by the H.223 multiplex may be of either “segmentable” or “non-segmentable” type, as defined in Recommendation H.223, and signalled by Recommendation H.245 when each channel is opened. AL-SDUs of segmentable logical channels may be segmented by the H.223 multiplex. AL-SDUs of non-segmentable logical channels are not segmented by the H.223 multiplex. Generally, segmentable channels should be used for variable bit rate information streams such as control, video, and data, while non-segmentable channels should be used for constant bit rate streams such as audio.

Receivers shall signal their capability to process various adaptation layers and channel types according to Recommendation H.245. Transmitters shall signal which adaptation layers, options, and channel type are used for each logical channel when opening the channel, according to Recommendation H.245.

## 6.5 Control channel

The control channel carries end-to-end control messages governing operation of the H.324 system, including capabilities exchange, opening and closing of logical channels, mode preference requests, multiplex table entry transmission, flow control messages, and general commands and indications.

There shall be exactly one control channel in each direction within H.324, which shall use the messages and procedures of Recommendation H.245. The control channel shall be carried on logical channel 0. The control channel shall be considered to be permanently open from the establishment of digital communication until the termination of digital communication; the normal procedures for opening and closing logical channels shall not apply to the control channel.

## Superseded by a more recent version

General commands and indications shall be chosen from the message set contained in Recommendation H.245. In addition other command and indication signals may be sent which have been specifically defined to be transferred in-band within video, audio or data streams (see the appropriate Recommendation to determine if such signals have been defined).

H.245 messages fall into four categories: Request, Response, Command, and Indication. Request messages require a specific action by the receiver, including an immediate response. Response messages respond to a corresponding request. Command messages require a specific action, but do not require a response. Indication messages are informative only, and do not require any action or response. H.324 terminals shall respond to all supported H.245 commands and requests as specified in Recommendation H.245, and shall transmit accurate indications reflecting the state of the terminal.

NOTE 1 – All control channel messages are sent over a link layer protocol which acknowledges correct receipt. This acknowledgment is distinct from the response messages, which convey content beyond that of correct receipt of the message.

H.324 terminals shall be capable of parsing all H.245 **MultimediaSystemControlPDU** messages, and shall send and receive all messages needed to implement required H.324 functions and those optional functions which are supported by the terminal. All messages and procedures of Recommendation H.245 related to required H.324 functions are required, except for those explicitly described as optional, or which are related to defined optional capabilities the terminal does not support. H.324 terminals shall send the **FunctionNotSupported** message in response to unrecognized request, response, or command messages.

A control channel indication, **UserInputIndication**, is available for transport of user input alphanumeric characters from a keypad or keyboard, equivalent to the DTMF signals used in analogue telephony. This may be used to manually operate remote equipment such as voice mail or video mail systems, menu-driven information services, etc. H.324 terminals shall support the transmission of user input characters 0-9, “\*”, and “#”. Transmission of other characters is optional.

NOTE 2 – If the encryption procedures of this Recommendation are in use, the control channel will not be encrypted. Users are therefore cautioned regarding the carriage of user data in the control channel, the use of non-standard messages, and the confidentiality risk from traffic analysis of the control channel.

### 6.5.1 Capabilities exchange

Capabilities exchange shall follow the procedures of Recommendation H.245, which provides for separate receive and transmit capabilities, as well as a system by which the terminal may describe its ability to operate in various combinations of modes simultaneously.

Receive capabilities describe the terminal’s ability to receive and process incoming information streams. Transmitters shall limit the content of their transmitted information to that which the receiver has indicated it is capable of receiving. The absence of a receive capability indicates that the terminal cannot receive (is a transmitter only).

Transmit capabilities describe the terminal’s ability to transmit information streams. Transmit capabilities serve to offer receivers a choice of possible modes of operation, so that the receiver may request the mode which it prefers to receive. The absence of a transmit capability indicates that the terminal is not offering a choice of preferred modes to the receiver (but it may still transmit anything within the capability of the receiver).

The transmitting terminal assigns each individual mode the terminal is capable of operating in a number in a **capabilityTable**. For example, G.723.1 audio, G.728 audio, and CIF H.263 video would each be assigned separate numbers.

These capability numbers are grouped into **AlternativeCapabilitySet** structures. Each **AlternativeCapabilitySet** indicates that the terminal is capable of operating in exactly one mode listed in the set. For example, an **AlternativeCapabilitySet** listing {G.711, G.723.1, G.728} means that the terminal can operate in any one of those audio modes, but not more than one.

These **AlternativeCapabilitySet** structures are grouped into **simultaneousCapabilities** structures. Each **simultaneousCapabilities** structure indicates a set of modes the terminal is capable of using simultaneously. For example, a **simultaneousCapabilities** structure containing the two **AlternativeCapabilitySet** structures {H.261, H.263} and {G.711, G.723.1, G.728} means that the terminal can operate either of the video codecs simultaneously with any

## Superseded by a more recent version

one of the audio codecs. The **simultaneousCapabilities** set { {H.261}, {H.261, H.263}, {G.711, G.723.1, G.728} } means the terminal can operate two video channels and one audio channel simultaneously: One video channel per Recommendation H.261, another video channel per either Recommendation H.261 or H.263, and one audio channel per either Recommendations G.711, G.723.1, or G.728.

NOTE – The actual capabilities stored in the **capabilityTable** are often more complex than presented here. For example, each H.263 capability indicates details including ability to support various picture formats at given minimum picture intervals, and ability to use optional coding modes. For a complete description, see Recommendation H.245.

The terminal's total capabilities are described by a set of **CapabilityDescriptor** structures, each of which is a single **simultaneousCapabilities** structure and a **capabilityDescriptorNumber**. By sending more than one **CapabilityDescriptor**, the terminal may signal dependencies between operating modes by describing different sets of modes which it can simultaneously use. For example, a terminal issuing two **CapabilityDescriptor** structures, one { {H.261, H.263}, {G.711, G.723.1, G.728} } as in the previous example, and the other { {H.262}, {G.711} }, means the terminal can also operate the H.262 video codec, but only with the low-complexity G.711 audio codec.

Terminals may dynamically add capabilities during a communication session by issuing additional **CapabilityDescriptor** structures, or remove capabilities by sending revised **CapabilityDescriptor** structures. All H.324 terminals shall transmit at least one **CapabilityDescriptor** structure.

Non-standard capabilities and control messages may be issued using the **NonStandardParameter** structure defined in Recommendation H.245. Note that while the meaning of non-standard messages is defined by individual organizations, equipment built by any manufacturer may signal any non-standard message, if the meaning is known.

Terminals may reissue capability sets at any time, according to the procedures of Recommendation H.245.

### 6.5.2 Logical channel signalling

Each logical channel carries information from a transmitter to a receiver, and is identified by a logical channel number unique for each direction of transmission.

Logical channels are opened and closed using the **OpenLogicalChannel** and **CloseLogicalChannel** messages and procedures of Recommendation H.245. When a logical channel is opened, the **OpenLogicalChannel** message fully describes the content of the logical channel, including media type, algorithm in use, H.223 adaptation layer and any options, and all other information needed for the receiver to interpret the content of the logical channel. Logical channels may be closed when no longer needed. Open logical channels may be inactive, if the information source has nothing to send.

Logical channels in Recommendation H.324 are unidirectional, so asymmetrical operation, in which the number and type of information streams is different in each direction of transmission, is allowed. However, if a receiver is capable only of certain symmetrical modes of operation, it may send a receive capability set that reflects its limitations. Terminals may also be capable of using a particular mode in only one direction of transmission.

Certain media types, including data protocols such as T.120 and LAPM, and video carried over AL3, inherently require a bi-directional channel for their operation. In such cases a pair of unidirectional logical channels, one in each direction, may be opened and associated together to form a bi-directional channel using the bi-directional channel opening procedures of the Recommendation H.245. Such pairs of associated channels need not share the same logical channel number, since logical channel numbers are independent in each direction of transmission.

### 6.5.3 Mode preferences

Receivers may request transmitters to send a particular mode using the H.245 **RequestMode** message, which describes the desired mode. Except when in receipt of **multipointModeCommand**. Transmitters may deny such requests, but should comply if possible.

# Superseded by a more recent version

## 6.5.4 Interface to multiplex

The control channel shall be segmentable and use logical channel 0. All H.324 terminals shall support transmission of H.245 control messages over the framed AL1 layer of Recommendation H.223 according to the procedures in Annex A, which ensure reliable delivery by retransmission of errored frames.

Annex A defines a Simple Retransmission Protocol (SRP) as a data link layer for Recommendation H.245. All H.324 terminals shall support the SRP defined in Annex A. Terminals may optionally use LAPM/V.42 as a data link layer instead of the SRP, if this mode is negotiated per the procedure in Annex A. In the LAPM/V.42 mode several control messages may be streamed using the procedures of LAPM, avoiding a wait for acknowledgment of each frame before the next message may be sent.

More than one H.245 control message may be sent in each SRP or LAPM frame.

## 6.5.5 Timer and counter values and protocol errors

All timers defined in Recommendation H.245 should have periods of at least the maximum data delivery time allowed by the data link layer carrying Recommendation H.245, including any retransmissions. For SRP, a period of at least  $T401 * N400$  (acknowledgement timer \* retransmit counter).

The H.245 retry counter N100 should be at least 3.

If a H.245 protocol error occurs, the terminal may optionally retry the H.245 procedure or may take other appropriate action, such as disconnection or reversion to analogue telephony, depending on predetermined configuration.

## 6.6 Video channels

All H.324 terminals offering video communication shall support both the H.263 and H.261 video codecs, except H.320 Interworking Adapters (which are not terminals) do not have to support H.263 (see 8.2). The H.261 and H.263 codecs shall be used without BCH error correction and without error correction framing. There are five standardized image formats: 16CIF, 4CIF, CIF, QCIF, and SQCIF.

CIF and QCIF are defined in Recommendation H.261. For the H.263 algorithm, SQCIF, 4CIF and 16CIF are defined in Recommendation H.263. For the H.261 algorithm, SQCIF is any active picture size less than QCIF, filled out by a black border, and coded in the QCIF format. For all these formats, the pixel aspect ratio is the same as that of the CIF format.

NOTE 1 – The resulting *picture* aspect ratio for H.263 SQCIF is different from the other formats.

Table 1 shows which picture formats are required, and which are optional for H.324 terminals which support video.

All video decoders shall be capable of processing video bit streams of the maximum bit rate which can be received by the implementation of the H.223 multiplex (maximum V.34 rate for single link,  $2 \times V.34$  rate for double link, etc.).

Which picture formats, minimum number of skipped pictures, and algorithm options can be accepted by the decoder is determined during the capability exchange using Recommendation H.245. After that, the encoder is free to transmit anything which is in line with the decoder's capability. Decoders which indicate capability for a particular algorithm option shall also be capable of accepting video bit streams which do not make use of that option.

When each video logical channel is opened, the maximum operating mode to be used on that channel is signalled to the receiver. The picture header within the video bit stream indicates which mode is actually used for each picture, within the stated maximum. Receivers may signal, via Recommendation H.245, a preference for a certain mode.

NOTE 2 – The maximum mode signalled includes maximum picture format, algorithm options, etc. For example, a video logical channel opened for CIF format may transmit CIF, QCIF, or SQCIF pictures, but not 4CIF or 16CIF. A video logical channel opened with only the **unrestrictedVector** and **arithmeticCoding** options may use neither, either, or both options, but shall not use options which were not signalled.

Other video codecs, and other picture formats, may also be used via H.245 negotiation. More than one video channel may be transmitted, as negotiated via the H.245 control channel.



# Superseded by a more recent version

NOTE 3 – The method of continuous presence multipoint operation, in which a single picture is divided into multiple sub-pictures, should not be used by H.324 terminals. Instead, multiple logical channels of video should be used.

TABLE 1/H.324

## Picture formats for video terminals

Picture format	Luminance Pixels	Encoder		Decoder	
		Rec. H.261	Rec. H.263	Rec. H.261	Rec. H.263
SQCIF	128 × 96 for H.263 (Note 3)	Optional (Note 3)	Required (Notes 1, 2)	Optional (Note 3)	Required (Note 1)
QCIF	176 × 144	Required	Required (Notes 1, 2)	Required	Required (Note 1)
CIF	352 × 288	Optional	Optional	Optional	Optional
4CIF	704 × 576	Not defined	Optional	Not defined	Optional
16CIF	1408 × 1152	Not defined	Optional	Not defined	Optional

NOTES

- Optional for H.320 interworking adapters.
- Mandatory to encode one of the picture formats QCIF and SQCIF; optional to encode both formats.
- H.261 SQCIF is any active size less than QCIF, filled out by a black border, coded in QCIF format.

### 6.6.1 Interface to multiplex

All H.324 terminals offering video communication shall support the required video codecs in segmentable logical channels using H.223 adaptation layer AL3, and using a control field of at least one octet. Support of retransmission is required in encoders, with a minimum AL3 **SendBufferSize** of 1024 octets.

The size of each AL-SDU, and their alignment with the video bit stream, is determined by video encoders, within the limit of the maximum AL3 SDU size the receiver indicates it is capable of. Video pictures may span more than one AL-SDU. H.261 AL-SDUs are not required to align with logical structures in the video bit stream. H.263 encoders shall align picture start codes with the start of an AL-SDU.

NOTE – H.263 pictures are a whole number of octets in length, since encoders add fill zero bits at the end of each picture as needed to fill out the final octet.

If video communication is supported only in one direction (transmit or receive), the H.223 adaptation layer AL3 protocol for the reverse direction shall also be supported, even if no video information will be sent on the reverse channel. Since the AL3 protocol requires a reverse channel for operation, logical channels using AL3 shall be opened using the H.245 procedures for opening associated logical channels in each direction of transmission (bi-directional channels).

While H.223 AL3 allows for the retransmission of video information with detected errors, the receiving terminal may decide not to request a retransmission, based on factors including but not limited to: the measured network delay, the error rate, whether the terminal is part of a multipoint conference, whether there is interworking with a H.320 terminal, and the effectiveness of its error concealment techniques.

When a video codec receives an AL-DRTX.indication from H.223 AL3, indicating that the local AL3 layer was unable to satisfy a retransmission request, it shall encode the next video picture in the INTRA coding mode.

Other video codecs, adaptation layers and options may be used via H.245 negotiation.

# Superseded by a more recent version

## 6.7 Audio channels

All H.324 terminals offering audio communication shall support both the high and low rates of the G.723.1 audio codec. G.723.1 receivers shall be capable of accepting silence frames. The choice of high rate, low rate, or silence is made by the transmitter, and is signalled to the receiver in-band in the audio channel, as part of the syntax of each audio frame. Transmitters may switch G.723.1 rates on a frame-by-frame basis, based on bit rate, audio quality, or other preferences. Receivers may signal, via Recommendation H.245, a preference for a particular audio rate or mode.

Alternative audio codecs may also be used, via H.245 negotiation. Coders may omit sending audio signals during silent periods after sending a single frame of silence, or may send silence background fill frames if such techniques are specified by the audio codec Recommendation in use.

More than one audio channel may be transmitted, as negotiated via the H.245 control channel.

NOTE – Each audio channel is independent. Grouping of audio channels into stereo pairs or other synchronized groups is for further study.

### 6.7.1 Delay compensation

The H.263 and H.261 video codecs require some processing delay, while the G.723.1 audio codec involves much less delay. Lip synchronization is not mandatory, but if it is to be maintained, additional delay must be added in the audio path to compensate.

An H.324 terminal shall not add delay for this purpose in its transmitting audio path. Instead, since video and audio coder delays may vary according to implementation, H.324 terminals shall signal, via **H223SkewIndication** messages in the H.245 control channel, the average skew by which their transmitted video signal trails the audio signal.

Intermediate processing points such as MCUs or interworking adapters may alter the video/audio skew (see 10.3), and shall transmit appropriately modified video/audio skew indications, reflecting their transmitted streams. Video signals shall not precede audio signals; if necessary, video path delay shall be added to prevent this.

Receiving terminals may optionally use this information to add appropriate delay in the audio path to achieve lip synchronization.

### 6.7.2 Maximum delay jitter

Audio AL-SDUs shall be transmitted periodically at an interval determined by the audio codec Recommendation in use (audio frame interval). The transmission of each audio AL-SDU at the H.223 multiplex shall commence no later than 10 milliseconds after a whole multiple of the audio frame interval, measured from transmission of the first audio frame (audio delay jitter). Transmitters capable of further limiting their audio delay jitter may so signal using the H.245 **maximumDelayJitter** parameter of the **H223Capability** message, so that receivers may optionally reduce their jitter delay buffers.

### 6.7.3 Interface to multiplex

All H.324 terminals offering audio communication shall support the G.723.1 codec using H.223 adaptation layer AL2. The use of the Sequence Number option of AL2 is optional, but is not recommended for G.723.1, since sequence numbers are generally not useful when the maximum delay jitter is less than the audio frame interval.

For all frame-oriented audio codecs, AL-SDUs shall be transmitted in non-segmentable logical channels. Receivers shall signal the maximum number of audio frames they are capable of accepting in a single audio AL-SDU. Transmitters may send any whole number of audio frames in each AL-SDU, up to the maximum stated by the receiver. Transmitters shall not split audio frames across AL-SDUs, and shall send whole numbers of octets in each audio AL-SDU.

NOTE 1 – Sample based codecs, such as G.711, shall be considered to be frame-oriented, with a frame size of one sample.

For audio algorithms such as G.723.1 which use more than one size of audio frame, audio frame boundaries within each AL-SDU shall be signalled in-band to the audio channel. For audio algorithms which use a fixed frame size, audio frame boundaries shall be implied by the ratio of AL-SDU size to audio frame size.

# Superseded by a more recent version

Other adaptation layers and options may be used via H.245 negotiation.

NOTE 2 – Transmitters using alternative audio codecs should also support AL2, unless another adaptation layer has been specified for use with a particular codec.

## 6.8 Data channels

All data channels are optional. Standardized options for data applications include:

- T.120-Series for point-to-point and multipoint audiographic teleconferencing including database access, still image transfer and annotation, application sharing, real-time file transfer, etc.
- T.84 (SPIFF) point-to-point still image transfer cutting across application borders.
- T.434 point-to-point telematic file transfer cutting across application borders.
- Recommendation H.224 for real-time control of simplex applications, including H.281 far end camera control.
- Network link layer, per ISO/IEC TR 9577 (supports IP and PPP network layers, among others).
- Unspecified user data from external data ports.

These data applications may reside in an external computer or other dedicated device attached to the H.324 terminal through a V.24 or equivalent interface (implementation dependent), or may be integrated into the H.324 terminal itself. Each data application makes use of an underlying data protocol for link layer transport. For each data application supported by the H.324 terminal, this Recommendation requires support for a particular underlying data protocol to ensure interworking of data applications.

NOTE – The H.245 control channel is not considered a data channel.

Standardized link layer data protocols used by data applications include:

- Buffered V.14 mode for transfer of asynchronous characters, without error control.
- LAPM/V.42 for error-corrected transfer of asynchronous characters. Additionally, depending on application, V.42 *bis* data compression may be used.
- HDLC frame tunnelling for transfer of HDLC frames.
- Transparent data mode for direct access by unframed or self-framed protocols.

All H.324 terminals offering real-time audiographic conferencing should support the T.120 protocol suite.

All data protocols shall operate within H.223 logical channel. All protocol procedures referring to link establishment or link termination (including setup and disconnection of physical channels) shall be interpreted as referring to opening and closing of logical channels, and shall not affect the H.324 physical link. For all protocol procedures which distinguish between an originator and an answerer, the H.324 master terminal, determined according to the **Master Slave Determination** procedure of Recommendation H.245, shall be the originator, and the slave terminal shall be the answerer.

More than one data channel, or more than one protocol may be used at the same time (each in a separate logical channel), as negotiated via the H.245 control channel. Other data protocols and applications may be used via H.245 negotiation.

### 6.8.1 Data protocols

This subclause describes these data protocols as if they are resident in the H.324 terminal, connected through a V.24 interface to an external computer or other dedicated device running the data application, as shown in Figure 2. The V.24 interface may be replaced by a logical equivalent. H.324 terminals with integrated data applications need not implement procedures related to the V.24 interface which have no net effect on the transmitted bit stream.

## Superseded by a more recent version

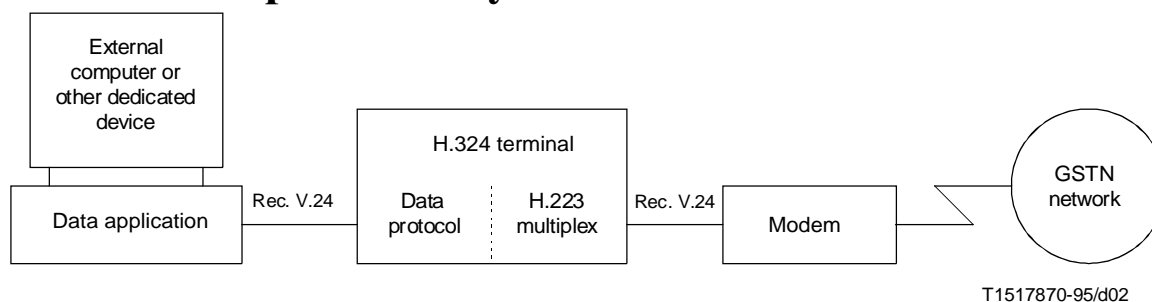

FIGURE 2/H.324

### Data application – Data protocol interface

H.324 terminals offering any data protocol described here shall support that protocol using segmentable logical channels and H.223 adaptation layer AL1, in the framed or unframed mode as specified below. Other ALs may be used if receivers indicate the capability to do so via H.245 negotiation.

#### 6.8.1.1 Buffered V.14

In the buffered V.14 mode, asynchronous characters and BREAK signals arriving at the V.24 interface shall be converted to a synchronous bit stream using the procedures of Recommendation V.14. Operation at the V.24 interface shall use buffering and flow-control across the DTE/DCE interface as described in 7.9/V.42 and 1.3/V.14.

The resulting bit stream shall be placed into the octets of an unframed AL1 AL-SDU, preserving the original bit ordering (least significant bit first). The unframed AL-SDU should be transferred to the underlying AL in a streaming mode, without waiting for the end of the AL-SDU (which will never occur).

If receipt of characters at the V.24 interface pauses, the terminal may omit transmission of octets containing only stop bits (because the line is idle), after transmitting the octet containing the final character, plus at least two stop bits.

The receiver shall perform the reverse operation.

#### 6.8.1.2 LAPM/V.42

In the LAPM/V.42 mode, asynchronous characters and BREAK signals arriving at the V.24 interface shall be transferred to the far-end using the procedures of Recommendation V.42 in the LAPM mode. The alternative procedure of Annex A/V.42 is not required.

The procedures of Recommendation V.42 shall be followed, except that:

- the flag sequence and transparency procedures of 8.1.1.2/V.42 shall not be performed, as the H.223 multiplex provides equivalent functions. Instead, the entire content of each frame between the opening and closing flags shall be placed in a single framed AL1 AL-SDU, without application of the zero-bit insertion transparency procedure;
- the detection phase of Recommendation V.42 shall be bypassed, proceeding directly to the protocol establishment phase;
- aborts shall be sent using the procedure of Recommendation H.223, instead of the procedure in Recommendation V.42;
- only frames shall be sent; interframe time filling flags shall not be sent.

The receiver shall perform the reverse operations.

If V.42 *bis* data compression is to be used, it shall be negotiated in-band to the LAPM/V.42 channel according to the procedures of Recommendation V.42 *bis*.

## Superseded by a more recent version

Since the LAPM/V.42 protocol requires a reverse channel for operation, LAPM/V.42 logical channels shall be opened using the H.245 procedures for opening associated logical channels in each direction of transmission (bi-directional channels).

H.324 terminals declaring capability for LAPM/V.42 in only one direction of transmission shall support the V.42/LAPM protocol for the reverse direction, even if no payload data will be sent on the reverse channel.

### 6.8.1.3 HDLC frame tunnelling

In the HDLC frame tunnelling mode, HDLC frames arrive at the V.24 interface from the data application.

If the V.24 interface is operating synchronously, inserted zero bits shall be removed and the entire content of each frame between the opening and closing flags shall be placed in a single framed AL1 AL-SDU, for transmission through the H.223 multiplex. Aborts shall be sent using the procedure of Recommendation H.223. Only frames shall be sent; flags (including interframe time filling flags) shall not be sent.

If the V.24 interface is operating asynchronously, HDLC frames arrive at the V.24 interface encoded as a sequence of asynchronous characters using octet-stuffing according to 4.5.2 of ISO/IEC 3309 instead of the usual zero-bit insertion transparency procedure of HDLC. This recognized alternative to the zero-bit insertion procedure makes the implementation of HDLC protocols over asynchronous serial links possible. Typical personal computer serial ports do not support synchronous operation, making this operation mode important. In particular, the PSTN basic mode profile of Recommendation T.123 specifies this mode of operation.

If operating asynchronously, the terminal shall receive HDLC frames at the V.24 interface according to the procedure given in Annex B. After execution of the receiver procedure given there, the entire content of each frame between the opening and closing flags shall be placed in a single framed AL1 AL-SDU, without application of the zero-bit insertion or octet-stuffing transparency procedures, for transmission through the H.223 multiplex. Aborts shall be sent using the procedure of H.223. Only frames shall be sent; flags (including interframe time filling flags) shall not be sent.

The receiver shall perform the reverse operation. The choice of asynchronous or synchronous V.24 interface is a local matter and does not need to be signalled to the far end.

NOTE – Since the HDLC octet-stuffing transparency procedure serves only to transport HDLC frames across an asynchronous interface, integrated terminals containing the HDLC protocol (T.120, H.224 or other) may omit the octet stuffing/unstuffing procedure, directly placing each HDLC frame in an AL-SDU, since the stuffing and unstuffing procedures cancel each other out inside the terminal. However, such integrated terminals shall still signal the HDLC frame tunnelling data protocol, for proper interworking with far-end terminals.

### 6.8.1.4 Transparent data

In the transparent data mode, octets arriving at the V.24 interface shall be placed directly into the octets of an unframed AL-SDU, preserving the original bit ordering (least significant bit first). No framing or transparency procedure shall be applied. The unframed AL-SDU should be transferred to the underlying AL in a streaming mode, without waiting for the end of the AL-SDU (which will never occur).

The receiver shall perform the reverse operation.

NOTE – The transparent data protocol may be considered equivalent to a variable-rate synchronous data channel, as it simply transports octets without any additional framing or protocol.

## 6.8.2 Data applications

Data applications make use of an underlying data protocol, as described in the previous subclause. This subclause describes these data applications as if they are resident in an external computer running the application, connected through a V.24 interface to the H.324 terminal. The V.24 interface may be replaced by a logical equivalent. Data applications integrated with the H.324 terminal may choose to omit procedures related to the V.24 interface which have no net effect on the transmitted bit stream.

### 6.8.2.1 T.120 multimedia teleconferencing applications

The T.120-Series of Recommendations is for point-to-point and multipoint audiographic teleconferencing including database access, still image transfer and annotation, application sharing, real-time file transfer, etc.

## Superseded by a more recent version

All H.324 terminals offering real-time audiographic conferencing should support the T.120 protocol suite.

H.324 terminals supporting T.120 shall use the PSTN basic mode profile protocol stack specified in Recommendation T.123, except that when arriving at the V.24 interface from the T.120 protocol implementation, the HDLC frame tunnelling data protocol described above shall be used. H.324 terminals shall declare the T.120 capability and mode if, and only if, they are compliant with this paragraph.

Since Recommendation T.120 requires a reverse channel for operation, T.120 logical channels shall be opened using the H.245 procedures for opening associated logical channels in each direction of transmission (bi-directional channels).

NOTE – T.120 data can also be transported as unspecified user data, but this mode is discouraged, since H.324 terminals will not be able to automatically negotiate use of T.120 in this mode.

### 6.8.2.2 T.84 (SPIFF) point-to-point still image transfer cutting across application borders

This application supports the point-to-point transfer of T.84 (SPIFF – Still Picture Interchange File Format) still images (JPEG, JBIG or Facsimile Gr.3/4 coded) through application borders (e.g. a digital photcamera connected through a V.24 interface to the sending H.324 terminal, and a digital photprinter connected through another V.24 interface to the receiving H.324 terminal).

The file exchange format to be used for ITU and ISO/IEC applications crosscutting application borders is defined in ITU-T Rec. T.84 | ISO/IEC 10918-3.

Recommendation H.245 should be used for the determination of still image profiles supported by the end-applications and the selection of an appropriate profile.

The data protocol used shall be LAPM/V.42 as described in 6.8.1.2.

NOTE – The T.120 protocol series (T.126) also performs still image transfer, among many other functions, within the framework of audiographic teleconferencing, and is preferred for such applications. Recommendation T.84 is concerned with passing still images over one or more application borders using the ITU-T | ISO/IEC standardized common file-interchange format. The T.84 (SPIFF) file exchange format is backwards compatible with JFIF, the predecessor “defacto standard” JPEG file format, widely used in PC applications and on the Internet. Recommendation T.126 is also compatible with this file format.

### 6.8.2.3 T.434 point-to-point telematic file transfer cutting across application borders

This application supports the point-to-point transfer of T.434 defined telematic files through application borders (e.g. an intelligent memory card connected to the sending H.324 terminal, and a computerized database connected through V.24 interface to the receiving H.324 terminal).

The data protocol used shall be LAPM/V.42 as described in 6.8.1.2.

NOTE – The T.120 protocol series (T.127, which also uses T.434) also performs file transfer, among many other functions, within the framework of audiographic teleconferencing, and is preferred for such applications. The T.434 application is concerned with point-to-point passing of telematic files over one or more application borders without implementing the entire protocol set of the T.120 series, which is indeed needed for file sharing among many users in a collaborative working environment.

### 6.8.2.4 H.224 real-time control protocol, for H.281 far-end camera control

Recommendation H.224 is for real-time simplex device control. The only currently standardized application is Recommendation H.281 for far-end camera control.

H.324 terminals supporting H.224 shall use the HDLC frame tunnelling protocol to transport HDLC frames. There shall be no more than one H.224 channel in use, and references in H.224 to the LSD channel of H.221 shall be interpreted as referring to the H.224 logical channel. The maximum transmission time requirements of H.224 shall be met, with the H.224 logical channel considered as operating at 4800 bit/s, regardless of the actual bit rate of the channel.

# Superseded by a more recent version

## 6.8.2.5 Network link layer

The network link layer data application supports ISO network layer protocols defined by ISO/IEC TR 9577, which include Internet Protocol (IP) and IETF Point-to-Point protocol (PPP), among others. The particular network layer protocol to be used shall be identified in H.245 data application capability and data mode messages using the Network Layer Protocol Identifier (NLPID) as defined in ISO/IEC TR 9577.

For the NLPID application, the link layer which is defined for use with asynchronous GSTN modems shall be used. If this link layer uses HDLC framing, the HDLC Frame Tunnelling protocol shall be supported by the H.324 terminal. Otherwise, the transparent data protocol shall be supported by the H.324 terminal.

NOTE – Use of the NLPID is extensively described in IETF RFC 1490, “Multiprotocol Interconnect over Frame Relay”.

## 6.8.2.6 External data ports and unspecified user data

All H.324 terminals offering external data ports for transport of unspecified user data shall support both the buffered V.14 data protocol mode and the HDLC frame tunnelling mode. Means shall be provided to configure the H.324 terminal for T.120 protocol on external data ports. If so configured, the HDLC frame tunnelling protocol and T.120 capability and mode shall be used by the terminal.

Other data protocols may optionally be used by H.245 negotiation.

## 7 Terminal procedures

The provision of the communication is made in the following steps:

- phase A: call setup of voiceband channel;
- phase B: initial analogue telephony communication;
- phase C: establishment of digital communication, modem training;
- phase D: initialization;
- phase E: communication;
- phase F: end of session;
- phase G: supplementary services and call clearing.

### 7.1 Phase A – call setup of voiceband channel

The calling terminal shall request the connection according to procedures for analogue telephony, according to national standards.

When a call is initiated by a terminal which is external to the modem (a separate physical item connected by an interface), the procedures of Recommendation V.25 *ter* shall be used. Upon successful completion of call set up, the H.324 terminal shall proceed to phase B.

### 7.2 Phase B – initial analogue telephony communication

#### 7.2.1 V.8 procedure

When the procedures of Recommendation V.8 are in use, phase B shall be bypassed, proceeding directly to phase C.

#### 7.2.2 V.8 *bis* procedure

When the procedures of Recommendation V.8 *bis* are in use, an optional phase B begins when the called party has answered. Phase B is normal analogue telephony voice mode. In this mode users have the opportunity to speak before proceeding to multimedia telephony.

# Superseded by a more recent version

If the terminal is conditioned to go directly into digital communication mode, Phase B shall be bypassed, proceeding directly to Phase C. If the terminal is conditioned for initial analogue telephony voice mode, the terminal shall proceed to Phase C when:

- the user manually causes the terminal to initiate a *V.8 bis* transaction; or
- the terminal detects an initiation signal from the distant terminal.

## 7.3 Phase C – establishment of digital communication, modem training

### 7.3.1 V.8 procedure

The terminal shall follow the call start-up procedure described in Recommendation V.8. The calling terminal should not transmit V.8 calling tones CT, CI, or CNG. The answer terminal shall support V.8 CM/JM exchanges, and shall transmit answer tone without waiting for call signals. H.324 terminals shall signal the “transmit and receive data” V.8 call function, and shall not signal a V.8 protocol category.

If the V.8 start-up procedure detects a V.34 modem, the start-up procedure for that modem shall be followed. Upon completion of the modem start-up procedure and establishment of digital communication, the terminal shall proceed to phase D – initialization.

If the V.8 procedure fails to detect a V.34 modem, or the handshake and the establishment of the digital connection is not successful after a suitable period the calling terminal may, depending on predetermined configuration, go to telephony mode, disconnect the line, or go to another operating mode more suitable for the detected modem. Such other modes are outside the scope of this Recommendation.

NOTE – The terminal shall wait for a suitable call setup period, in addition to processing, signal detection, and maximum round trip delays, before deciding on further action.

### 7.3.2 V.8 bis procedure

The terminal shall follow the call start-up procedure described in Recommendation V.8 *bis*. If the V.8 *bis* procedure detects that the distant terminal is not capable of V.8 *bis*, but is capable of V.8, the Phase C procedure for V.8 (above) shall be followed. If the V.8 *bis* procedure detects a distant H.324 terminal, the V.34 start-up procedure shall be followed.

Upon completion of the V.8 *bis* procedures and establishment of digital communication, the terminal shall proceed to Phase D – initialization.

NOTE – Some successful V.8 *bis* transactions result in a return to telephony mode (Phase B).

If the V.8 *bis* procedure fails, results in a return to analogue telephony, or the handshake and the establishment of the digital connection is not successful after the period specified in Recommendation V.8 *bis*, the calling terminal may, depending on predetermined configuration, go to telephony mode, disconnect the line, or go to another operating mode more suitable for the detected modem. Such other modes are outside the scope of this Recommendation.

## 7.4 Phase D – initialization

After digital communication has been established, a minimum of 16 HDLC flags shall be transmitted in order to ensure synchronization. Following this, system to system communication shall be initiated using the H.245 control channel. Since no multiplex table entries have yet been sent to the receiver, initial control messages shall be sent using multiplex table entry 0.

Terminal system capabilities are exchanged by transmission of the H.245 **TerminalCapabilitySet** message. This capability PDU shall be the first message sent. The H.245 **MasterSlaveDetermination** message shall also be sent at this time, in which the terminals exchange random numbers, according to the procedure in Recommendation H.245, to determine the master and slave terminals. H.324 terminals shall be capable of operating in both master and slave modes, and shall set **terminalType** to 128 and set **statusDeterminationNumber** to a random number in the range 0 to  $2^{24} - 1$ . Only one random number shall be chosen by the terminal for each call, except in the case of identical random numbers, as described in Recommendation H.245.



# Superseded by a more recent version

If the initial capability exchange or master/slave determination procedures fail, these should be retried at least two additional times before the terminal abandons the connection attempt and proceeds to Phase G.

NOTE – The range of terminalTypes from 0 to 127 is reserved for possible use by MCUs or other non-terminal devices which may need to be slave at all times, and the range 129 to 255 is reserved for possible use by MCUs or other non-terminal devices which may need to be master at all times.

After these procedures are complete, and the far-end's capabilities have been received, the procedures of Recommendation H.245 may then be used to open logical channels for various information streams. Multiplex table entries may be sent before or after logical channels are opened, but information shall not be transmitted over a logical channel until the channel is open, and an appropriate H.223 multiplex table entry has been defined.

## 7.4.1 Exchange of video by mutual agreement

The indication **videoIndicateReadyToActivate**, “Video Indicate Ready-to-activate”, is defined in Recommendation H.245. Its use is optional, but when used the procedure shall be as follows:

Terminal X has been set so that video is not transmitted unless, and until, the remote terminal has also indicated readiness to transmit video. Terminal X shall send the indication **videoIndicateReadyToActivate** when the initial capability exchange has been completed, but shall not transmit a video signal until it has received either **videoIndicateReadyToActivate** or incoming video.

A terminal which has not been set in this optional way is not obliged to wait until receipt of **videoIndicateReadyToActivate** or video before initiating its video transmission.

## 7.5 Phase E – communication

During a session the procedures for changing logical channel attributes, capability, receive mode etc. shall be carried out as defined in Recommendation H.245.

### 7.5.1 Rate changes and retrains

During phase E communication, the modem may retrain or alter its rate of data transmission, with or without momentary disruption of data transmission and loss of data. Upon any such momentary disruption of data transfer, the terminal shall not restart phase D, but shall remain in phase E and execute the normal H.324 error recovery procedures according to Recommendation H.223.

### 7.5.2 Involuntary disconnection

Should the terminal detect involuntary, unrecoverable loss of modem communication, or of the underlying GSTN connection, the terminal shall immediately proceed to phase G, analogue telephony mode or line disconnection, bypassing phase F.

## 7.6 Phase F – end of session

Either terminal may initiate the end of the session. The initiating terminal shall use the following procedure:

- 1) For each logical channel carrying video, it shall stop sending video at the end of a complete picture and then close the logical channel.
- 2) It shall close all logical channels carrying data and audio.
- 3) It shall transmit the H.245 message **EndSessionCommand**, and then discontinue all H.245 message transmissions. This message shall contain an indication to the far end regarding the mode the terminal will enter after the end of the session (disconnect line, analogue telephony, or other mode).
- 4) On subsequent receipt of **EndSessionCommand** from the remote end, it shall proceed to Phase G, except that if the initiating terminal indicated an intention to disconnect the line after the end of session, the terminal shall not wait for receipt of **EndSessionCommand** from the remote end, but shall proceed directly to Phase G.

A terminal receiving **EndSessionCommand** without first having transmitted it shall follow 1) to 3) above, then proceed to phase G.

# Superseded by a more recent version

## 7.7 Phase G – supplementary services and call clearing

If the terminal arrived at phase G by involuntary disconnection, it shall disconnect or revert to analogue telephony, depending on predetermined configuration.

A terminal wishing to terminate a call shall first initiate session end procedure described in phase F.

In phase G, the terminal shall proceed as it indicated in the **EndSessionCommand** message. If it indicated a change to another digital communication mode, it shall begin the new mode at the equivalent of phase D. Otherwise, it shall initiate the clear-down procedures defined in Recommendation V.34, except that it shall not physically disconnect the GSTN connection if it indicated an intention to revert to analogue telephony mode.

These procedures ensure that:

- the distant terminal does not erroneously invoke a fault procedure;
- the human user gets the right indications via tones and announcements from the network exchange;
- relevant messages can be displayed for the human user by the terminal.

## 8 Interoperation with other terminals

### 8.1 Speech only terminals

H.324 videophones shall support interoperation with analogue speech-only telephones.

### 8.2 H.320 multimedia telephone terminals over the ISDN

Interoperation with multimedia telephone terminals over the ISDN (H.320) can be provided by:

- using on the ISDN an interworking adapter; or
- using dual-mode (ISDN and GSTN) terminals on the ISDN

An H.324/H.320 interworking adapter is located at the interface between ISDN and GSTN signals. It transcodes the H.223 and H.221 multiplexes, and the content of control, audio, and data logical channels between the H.324 and H.320 protocols.

In order to ease communication between H.324 and H.320 terminals via interworking adapters, H.324 terminals which support video shall support the H.261 video codec in the QCIF picture format so that the additional delay of video transcoding can be avoided. When this mode is in use, interworking adapters shall insert and remove H.261 and H.263 BCH error correction and error correction framing as appropriate for each terminal type. H.324 terminals shall respond to the H.245 **FlowControlCommand**, so that transmitted H.324 video streams can be matched to the H.320 video bit rate in use by the H.221 multiplex.

Dual-mode (Recommendations H.320 and H.324) terminals on the ISDN shall send H.324 GSTN signals by the use of a “virtual modem”, which generates and receives a V.34 analogue signal encoded as a G.711 audio bit stream over the ISDN.

### 8.3 Multimedia telephone terminals over mobile radio

It is expected that multimedia telephone terminals will also be used on mobile radio networks. Rate matching between wireless terminals and GSTN terminals can be achieved by the use of the H.245 **FlowControlCommand**. Wireless operation is for further study.

## 9 Optional enhancements

### 9.1 Data facilities

A terminal may have physical I/O ports for external telematic and other equipment, or there may be data applications within the terminal itself. Data transmission may be activated and deactivated by local action.

# Superseded by a more recent version

## 9.2 Encryption

Encryption may optionally be used by H.324 terminals. Encryption, including selection of algorithm and key exchange, shall conform to the procedures of Recommendations H.233 and H.234 with the following modifications to the procedures defined in Recommendation H.233. The ability to support encryption shall be signalled by the presence of the **h233EncryptionTransmitCapability** and **h233EncryptionReceiveCapability** parameters of the **Capability** message of H.245.

In Recommendation H.233, specific reference is made to H.221 in describing how encryption takes place. In applying H.233 to H.324 terminals, references to H.221, FAS, and BAS channels therein shall be ignored and appropriate substitute Recommendations be taken from this subclause. Messages referred to as carried in the H.221 ECS channel shall be re-interpreted as being carried within the **encryptionSE** parameter of the H.245 **EncryptionCommand** or Encryption Initialization Vector (EIV) logical channel, as specified below.

### 9.2.1 EncryptionSE messages

H.233 session exchange (SE) messages shall be carried in the **encryptionSE** parameter of the H.245 **EncryptionCommand** message. Since the H.245 control channel is carried on a reliable data link layer using retransmission of errored frames, the error protection bits described in Recommendation H.233 shall not be applied to SE messages.

The H.233 header for SE messages shall have the value binary 00000000, indicating an SE message in a single block, not followed by related blocks.

The H.233 media identifier value shall be binary 00000000, which shall indicate encryption of all logical channels except for the EIV and H.245 control channels. The use of other values is for further study.

NOTE – Non-standard encryption algorithms may be referenced in SE messages after associating a non-standard algorithm with a H.233 Algorithm Identifier value using the **encryptionAlgorithmID** parameter of the **EncryptionCommand** message.

### 9.2.2 Encryption Initialization Vector (EIV) channel

The Encryption Initialization Vector (EIV) logical channel is used for the transmission of H.233 Initialization Vector (IV) messages.

To ensure accurate synchronization of the IV messages with the H.223 multiplex bit stream, the EIV channel is an independent logical channel which shall be non-segmentable, and shall use adaptation layer AL2 of the H.223 multiplex. The entire IV message, exactly as defined in Recommendation H.233, including error protection bits, shall be placed in a single AL-SDU. The sequence number option of AL2 shall not be used.

Messages carried within the EIV channel shall retain the error protection mechanism of Recommendation H.233.

### 9.2.3 Encryption procedure

The encryptor shall produce a pseudo-random bit stream (cipher stream) corresponding to all bits output by the H.223 multiplex prior to insertion of flags and application of the HDLC zero-bit insertion procedure.

When encryption is activated according to Recommendation H.233, the H.223 bit stream shall, prior to flag insertion and application of the HDLC zero-bit insertion procedure, be exclusive-OR with the pseudo-random bit stream generated by the encryptor. However, the exclusive-OR procedure shall not be applied to the H.223 header octet and all octets belonging to the H.245 control channel or EIV channel, which shall all be passed transparently to the HDLC zero-bit insertion and flag insertion stage.

For each transmitted H.223 header octet or octet belonging to the EIV or control channels, eight bits shall be discarded from the pseudo-random bit stream generated by the encryptor. Nothing is discarded from the pseudo-random bit stream for transmitted flags or for bits added by the HDLC zero-bit insertion process.

The receiver shall apply the reverse procedure.

### 9.2.4 Encryption initialization vectors

Once an encrypted session is in progress the transmitter should periodically send new IV messages in order to limit the duration of repeated pseudo-random bit stream in the event of a collision with a previously used state of the pseudo-random bit stream generator. The frequency of these messages is left to the discretion of the implementor.

## Superseded by a more recent version

As shown in Figure 3, new Initialization Vectors (IVs) take effect at the start of the next H.223 MUX-PDU following the MUX-PDU containing an IV message. The old IV continues in effect through the entirety of the MUX-PDU containing the IV message, at the end of which any remaining pseudo-random bits generated using the old IV are discarded. In order for the receiver to have time to process the new IV before needing to use it, the transmitter shall wait a minimum time after sending the last octet of the IV message, as specified by the receiver's **h233IVResponseTime** capability, before starting transmission of the next MUX-PDU. If necessary, the transmitter shall send idle flags to meet the receiver's **h233IVResponseTime** requirement.

NOTE – Definition, by the implementor, of an appropriate H.223 multiplex table entry allows octets from other logical channels to follow an IV message within the same MUX-PDU so that no transmission bandwidth is squandered in meeting the receiver's IV processing delay requirement.

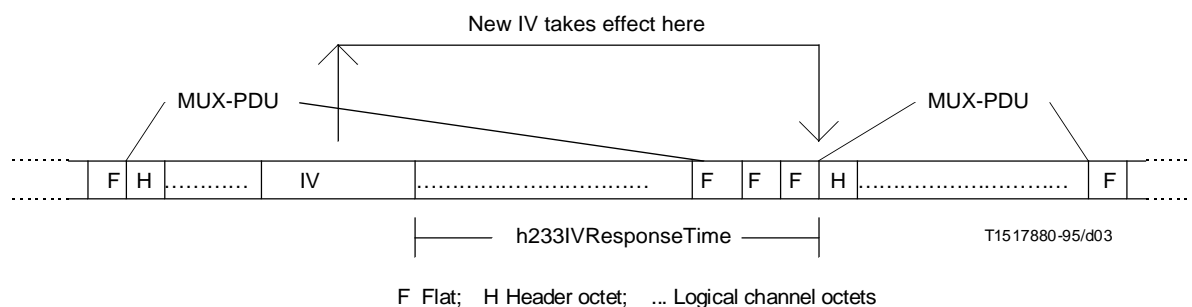

FIGURE 3/H.324

### Encryption IV synchronization

#### 9.2.5 Error recovery

In the event of line errors that cause flag emulation, flag erasure, or erroneous HDLC zero-bit removal, it is possible that a newly received flag, signifying the end of the previous MUX-PDU, will not align with the octet boundaries of the preceding data. In order to maximize the resilience of the encryption system against synchronization loss under these circumstances, the decryptor should, for each new flag received, re-align its pseudo-random bit stream generator to the nearest octet boundary. This allows recovery from up to at least three zero-bit removal errors between valid flags, although it does not provide any protection against flag emulation or erasure.

In the event that the receiver suspects that it has lost encryption synchronization it shall send an **encryptionIVrequest** command, except that it should not re-send such commands at intervals less than the maximum expected round trip response time.

Upon receipt of an **encryptionIVrequest** command, the transmitter shall, at its earliest opportunity, send a new IV message, except that it should ignore **encryptionIVrequest** commands received within the minimum expected round trip response time since sending the last IV message.

#### 9.3 Multilink

Provision for multilink operation is for further study.

### 10 Multipoint considerations

H.324 terminals may be used in multipoint configurations via interconnection through MCUs, as indicated in Figure 4. (Note that cascaded MCU operation is for further study.)

#### 10.1 Establishment of common mode

MCUs may force terminals into a particular common mode of transmission by sending to the terminal a receive capability set listing only the desired mode of transmission. H.324 terminals shall obey the **MultipointModeCommand** message of Recommendation H.245.

## Superseded by a more recent version

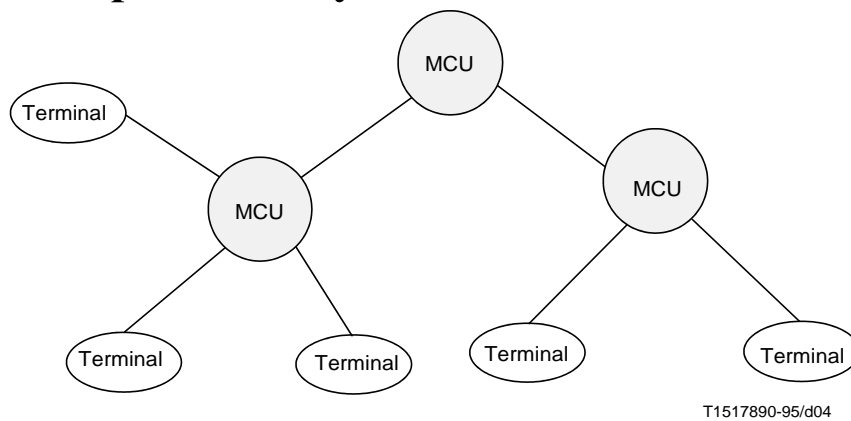

FIGURE 4/H.324  
Multipoint configuration

### 10.2 Multipoint rate matching

Since the modems on each link in a multipoint configuration may be operating at different bit rates, MCUs may choose to send H.245 **FlowControlCommand** messages to limit the transmitted bit rates to those which can be sent to receivers.

### 10.3 Multipoint lip synchronization

In a multipoint configuration, each terminal may be transmitting a different **H223SkewIndication** message for associated video and audio channels. To enable lip synchronization at receiving terminals, MCUs shall transmit accurate **H223SkewIndication** messages. MCUs may accomplish this by adding delay to equalize the audio/video skew for all transmitting terminals, or, when switching between broadcasting terminals, may transmit a new **H223SkewIndication** message reflecting the audio/video skew of the current broadcaster.

### 10.4 Multipoint encryption

In a multipoint configuration the MCU is considered to be a trusted entity. Each port of the MCU encrypts/decrypts the H.223 bit stream from the H.324 terminal or MCU attached to that port as though it were an H.324 terminal in accordance with 9.2.

### 10.5 Cascaded MCU operation

Multipoint operation in a cascaded MCU configuration is for further study.

## 11 Maintenance

### 11.1 Loopbacks for maintenance purposes

Some loopback functions are defined in Recommendation H.245 to allow verification of some functional aspects of the terminal, to ensure correct operation of the system and satisfactory quality of the service to the remote party. The message loopback off (**MaintenanceLoopOffCommand**) requires that all loopbacks currently in effect be turned off.

# Superseded by a more recent version

## 11.1.1 Normal mode

Normal (no loopback) operation mode is illustrated in Figure 5 a).

## 11.1.2 System loopback

Operation in system loopback mode is for further study.

## 11.1.3 Media loopback

Media loopback operates at the analogue I/O interface (toward modem). Upon receiving the **mediaLoop** request as defined in Recommendation H.245, loopback of the content of the selected logical channel shall be activated as close as possible to the analogue interface of the video/audio codec towards the video/audio codec, so that decoded and re-coded media content is looped, as indicated in Figure 5 c). While in this mode, the terminal shall respond normally to received data including H.245 messages. Media loopback provides a subjective test of H.324 operation through the far-end codec for human user evaluation. It should be used only on video and audio channels.

This loopback is optional, and should be used only on logical channels opened using the bidirectional channel procedures of Recommendation H.245.

## 11.1.4 Logical channel loopback

Logical channel loopback operates in the H.223 multiplex (toward modem). Upon receiving the **logicalChannelLoop** request, each received H.223 MUX-SDU for the specified logical channel shall be looped back to the transmitter on the corresponding reverse logical channel, as indicated in Figure 5 d). While in this mode, the terminal shall respond normally to received data, including H.245 messages.

This loopback is optional, and should be used only on logical channels opened using the bidirectional channel procedures of Recommendation H.245.

# Superseded by a more recent version

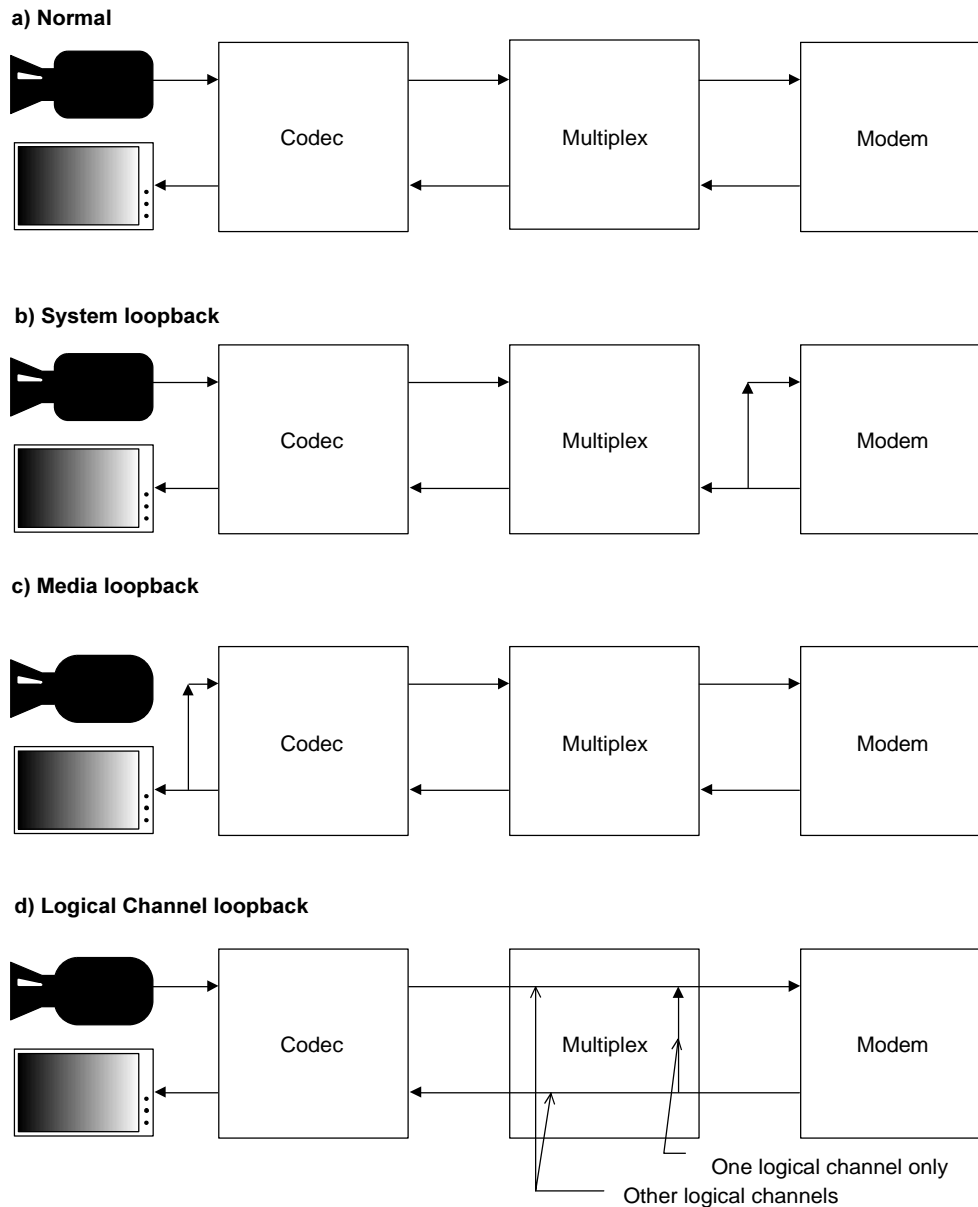

T1523340-96/d05

FIGURE 5/H.324

## Loop back

# Superseded by a more recent version

## Annex A

### Protocol stack for control channel

(This annex forms an integral part of this Recommendation)

This annex defines the data protocol stack for use with the H.324 control channel.

#### A.1 General

Figure A.1 shows the control channel protocol stack for use with this Recommendation.

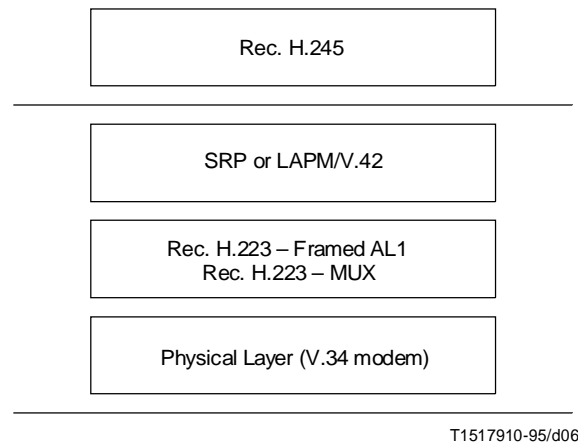

FIGURE A.1/H.324

#### Protocol stack for H.324 control channel

The control protocol of Recommendation H.245 requires a reliable link layer for proper operation.

Two means of transporting **MultimediaSystemControlPDU** messages are defined: Simple Retransmission Protocol (SRP) frames and LAPM/V.42 I frames. In the SRP mode each SRP command frame must be acknowledged with an SRP response frame before the next command can be transmitted. In the LAPM/V.42 mode multiple frames may be sent in a streaming mode, before an acknowledgment is received for the first frame. All H.324 terminals shall support the SRP mode, and shall use SRP as the H.245 link layer upon initial communication. The LAPM/V.42 mode is optional, and is preferred for use by complex terminals.

In both cases, bits produced by the X.691 encoding process shall be put into the octets of an information field, with the first bit generated going into the Most Significant Bit (MSB) of the first octet, and progressing down to the Least Significant Bit (LSB) of the last octet. One or more H.245 **MultimediaSystemControlPDU** messages may be sent in each information field, to be transported in a single SRP or LAPM frame.

H.324 terminals capable of using LAPM/V.42 as the control channel link layer shall so indicate by setting the **transportWithI-frames** parameter of the **H223Capability** structure true. Such terminals, upon receiving the corresponding indication from the far-end terminal, shall henceforth, and without further notification of intent, proceed



# Superseded by a more recent version

to establish an error-corrected connection according to the procedures given in 6.8.1.2 and subsequently transmit control channel messages only using LAPM/V.42 for the duration of the connection. The terminal shall, however transmit a SRP response message in reply to any SRP command message received.

The transition to LAPM/V.42 mode shall take place regardless of the state of any H.245 transactions in progress; any pending transactions shall proceed using LAPM/V.42 for transfer of additional messages.

NOTE – Since the H.245 control channel is not considered a data channel, ability to operate the control channel over LAPM/V.42 is signalled only in the **transportWithI-frames** parameter of **H223Capability**, and is not signalled as a data protocol.

## A.2 SRP mode

All terminals shall support the transfer of **MultimediaSystemControlPDU** messages using SRP mode. Each SRP frame shall be placed in a single framed AL1 AL-SDU.

NOTE – The procedures of the SRP mode are based on those of XID frame transfer in Recommendation V.42.

### A.2.1 SRP command frames

SRP command frames, as shown in Figure A.2, shall be used to send H.245 control messages. All fields shall be formatted as specified in Recommendation H.223 (note that these formats are consistent with Recommendation V.42).

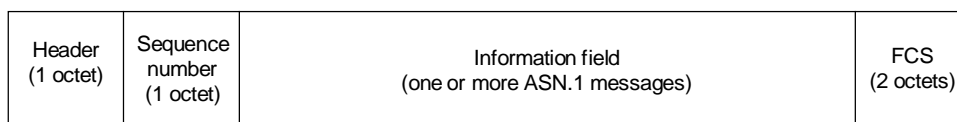

T1517920-95/d07

FIGURE A.2/H.324

Format of SRP command frames for **MultimediaSystemControlPDU** messages

The SRP command frame header octet shall have the value binary 11111001 (decimal 249). This may be considered equivalent to an HDLC address octet with the DLCI value 62, C/R bit set to 0, and EA bit set to 1.

The sequence number shall be set arbitrarily by a terminal for the first SRP command frame sent and shall be incremented modulo 256 for each new SRP command frame sent. Retransmissions of the same SRP frame, sent according to the procedures below, shall not increment the sequence number, but shall use the same sequence number as the original transmission, so that receivers can distinguish between separate valid messages and retransmissions of a single message (possibly sent in error if the original SRP response frame was lost).

The information field shall contain a whole number of octets, not to exceed 2048 octets, representing one or more H.245 **MultimediaSystemControlPDU** messages. The procedure specified by Recommendation X.691 shall be used to fill any spare bits in the last octet.

The FCS field shall contain a 16-bit CRC, applied to the entire frame content, as described in 8.1.1.6.1/V.42.

### A.2.2 SRP response frames

SRP response frames shall be used to acknowledge correct receipt of SRP command frames from the far-end. Each SRP response frame shall consist of a header octet and FCS field only, and shall not contain any other fields.

The SRP response frame header octet shall have the value binary 11111011 (decimal 251). This may be considered equivalent to an HDLC address octet with the DLCI value 62, C/R bit set to 1, and EA bit set to 1.

## Superseded by a more recent version

The FCS field shall contain a 16-bit CRC, applied to the entire frame content, as described in 8.1.1.6.1/V.42.

### A.2.3 SRP procedure at transmitter

The SRP procedure makes use of an acknowledgment timer T401 and retransmission counter N400.

The period of T401 is a local matter; the two terminals may operate with different periods of T401. Appendix IV/V.42 shows the various factors that influence T401.

The maximum value of N400 is a local matter; the two terminals may operate with different maximum values of N400. While no default maximum is specified for N400, it should be at least 5.

When the terminal transmits a new SRP command frame, timer T401 shall then be started and the retransmission counter, N400, reset. No additional SRP command frames shall be sent until a response SRP frame with correct header and FCS is received, or timer T401 expires.

If a valid SRP response frame is received, a new SRP command frame, with an incremented sequence number, may be transmitted.

If timer T401 expires before receipt of a valid SRP response frame, the terminal shall:

- retransmit the SRP command (with the same sequence number) as above;
- restart timer T401; and
- increment the retransmission counter (N400).

After retransmission of the SRP command N400 times and failure to receive a valid SRP response, the terminal shall consider modem communication to be lost, and take appropriate action.

### A.2.4 SRP procedure at receiver

On receipt of an SRP command frame with correct header and FCS the receiving terminal shall acknowledge by transmitting an SRP response frame.

If the received SRP command frame has the same sequence number as the previously received command frame, it shall not be passed to the H.245 layer, since it is a retransmission of an already-processed command.

Receipt of all other frames shall be ignored, except that if the terminal has signalled ability to operate in LAPM/V.42 mode, the receiver shall check the DLCI value of received frame header. If the DLCI value matches that specified for use in the LAPM/V.42 mode, the terminal shall respond according to the procedures of LAPM/V.42, as described below.

## A.3 LAPM/V.42 mode

Terminals may optionally support the transfer of **MultimediaSystemControlPDU** messages using LAPM/V.42.

SRP frames shall be used to transfer **MultimediaSystemControlPDU** messages before LAPM/V.42 transmission is initiated but shall not be used for this purpose after LAPM/V.42 transmission has been used.

In the LAPM/V.42 mode, the information field, as defined for the SRP mode above, shall be placed into a single LAPM/V.42 I-frame and transferred using procedures of LAPM/V.42, as in 6.8.1.2, except that the procedures for opening logical channels shall not be used, as the control channel is considered already open at the start of digital communication.

The address field shall be one octet with the 6-bit DLCI field set to binary 111111 (decimal 63).

V.42 *bis* data compression should not be used.

Default values for all V.42 parameters shall be as specified in Recommendation V.42, except for N401, maximum number of octets in an information field, which shall have a default value of 2048 octets, in order to accommodate large capability sets.

# Superseded by a more recent version

## Annex B

### HDLC frame structure transparency for asynchronous transmission

(This annex forms an integral part of this Recommendation)

When operating in the HDLC frame tunnelling mode, the H.324 terminal shall implement at the asynchronous V.24 interface the following procedures taken from 4.5.2 of ISO/IEC 3309:

The control escape octet is a transparency identifier that identifies an octet occurring within a frame to which the following transparency procedure is applied. The encoding of the escape octet is given in Figure B.1.

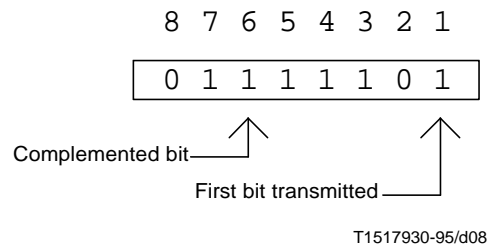

FIGURE B.1/H.324

#### Control escape octet for HDLC frame tunnelling procedure

The transmitter shall examine the frame content between the opening and closing flag sequences (01111110) including the address, control, and FCS fields and, following completion of the FCS calculation, shall:

- a) upon the occurrence of the flag or a control escape octet, complement the 6th bit of the octet; and
- b) insert a control escape octet immediately preceding the octet resulting from the above prior to transmission.

The receiver shall examine the frame content between the two-flag octets and shall, upon receipt of a control escape octet and prior to FCS calculation:

- a) discard the control escape octet; and
- b) restore the immediately following octet by complementing its 6th bit.

Other octet values may optionally be included in the transparency procedure by the transmitter.

# Superseded by a more recent version

## Appendix I

### Bit and octet order

(This appendix does not form an integral part of this Recommendation)

This appendix is supplied as a summary of bit and octet order in H.324, including Recommendations H.223, H.261, H.263, H.245 and G.723.1. In case of any discrepancy the normative text of the various Recommendations shall take precedence over this appendix.

Recommendations H.261, H.263, G.723.1 and H.245 each produce a sequence of bits which are delivered as octets to the H.223 multiplex. Within this sequence of bits there are fields of various lengths, in some cases aligned with octet boundaries. In the case of Recommendations H.261, H.263, G.723.1 and H.245 these fields are ordered Most Significant Bit (MSB) first. Figure I.1 illustrates this, with “M” indicating the MSB of each field and “L” indicating the Least Significant Bit (LSB) of each field.

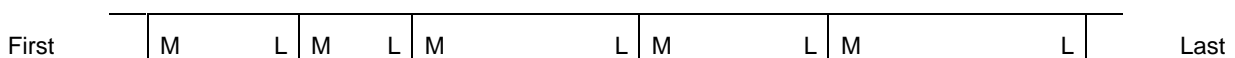

FIGURE I.1/H.324

### Output from Recommendations H.261/H.263/G.723.1/H.245

Upon delivery to the H.223 multiplex, this bit sequence is split into octets, each with a defined MSB/LSB position, as shown in Figure I.2.

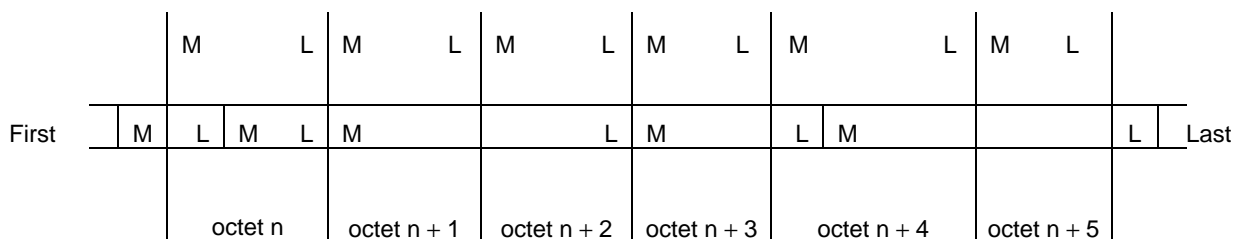

FIGURE I.2/H.324

### Output split into octets

The H.223 multiplex then transmits each of these octets in the order LSB first (the reverse of the original order), applying the transparency procedure (inserting a “0” after each sequence of five “1”s) as it does so.

## Superseded by a more recent version

For example, a sequence of six octets, with hexadecimal values 0x92, 0xF1, 0x39, 0x35, 0x31, 0x30 would be transmitted as shown in Figure I.3.

	M	L	M	L	M	L	M	L	M	L	M	L	
	octet n		octet n + 1		octet n + 2		octet n + 3		octet n + 4		octet n + 5		
First	10010010	11110001	00111001	00110101	00110001	00110000							Last
	0x92		0xF1		0x39		0x35		0x31		0x30		

is transmitted as:

First	01001001	10001111	10011100	10101100	10001100	00001100	Last
	↑ 0 bit will be inserted here						

FIGURE I.3/H.324

### Example sequence

## Appendix II

### V.8 bis codepoints

(This appendix does not form an integral part of this Recommendation)

V.8 bis capability exchange may be used during call setup to help terminals quickly decide, in the most common cases, if operation in H.324 mode is desired. V.8 bis capabilities indicate only the most basic and commonly used modes, and are not a substitute for H.245 procedures. If a H.324 operation mode not signalled by V.8 bis is desired, the terminal must complete call establishment and perform a H.245 capabilities exchange to determine if the far-end terminal supports the desired mode.

Within the Recommendation V.8 bis Communications Capabilities (CC) field for Recommendation H.324, the CC field is formatted into one or more subfields. Each subfield ends with the octet in which bit [n] is set to 1. Following the first subfield, the remaining subfields, if present, shall appear in the same order in which the bits indicating their presence are transmitted.

NOTE 1 – Implementors should refer directly to Recommendation V.8 bis for the actual bit assignments.

In the first subfield the following bits are allocated:

Name	Meaning
Video	Shall be set only if bidirectional video is supported per 6.6;
Audio	Shall be set only if bidirectional audio is supported per 6.7;
Encryption	Shall be set only if encryption is supported per 9.2;
Data	Indicates that a data subfield is present. Shall be set only if one or more bits in the data subfield are set.

NOTE 2 – Possible future allocations include profiles (new subfield).

# Superseded by a more recent version

In the data subfield, the following bits are allocated:

Name	Meaning
T120	Shall be set only if T120 conferencing is supported per 6.8.2.1;
T84	Shall be set only if T84 still image transfer is supported per 6.8.2.2;
T434	Shall be set only if T434 file transfer is supported per 6.8.2.3;
V.42	Shall be set only if V.42 user data is supported per 6.8.1.2/6.8.2.6;
V.14	Shall be set only if V.14 user data is supported per 6.8.1.1/6.8.2.6;
PPP	Shall be set only if IETF point-to-point protocol is supported via the Network Layer Protocol Identifier (NLPID) per 6.8.2.5.

NOTE 3 – Other modes beside those indicated in Recommendation V.8bis, such as unidirectional modes, may be supported by terminals as signalled via H.245 capabilities exchange.

## Bibliography

(This bibliography does not form an integral part of this Recommendation)

CCITT Recommendation G.728 (1992), *Coding of speech at 16 kbit/s using low-delay code excited linear prediction.*

ITU-T Recommendation H.230 (1993), *Frame-synchronous control and indication signals for audiovisual systems.*

ITU-T Recommendation H.262 (1995) | ISO/IEC 13818-2:1995, *Information technology – Generic coding of moving pictures and associated audioinformation-video.*

ITU-T Recommendation T.30 (1993), *Procedures for document facsimile transmission in the general switched telephone network.*

Recommendation T.35 (1991), *Procedure for the allocation of CCITT defined codes for non-standard facilities.*

Recommendation T.51 (1992), *Latin based coded character sets for telematic services.*

ITU-T Recommendation X.680 (1994), *Information technology – Abstract Syntax Notation One (ASN.1): Specification of basic notation.*

MALIS (A.) *et al.*: Multiprotocol Interconnect over Frame Relay, *IETF RFC 1490*, July 1993.

SIMPSON (W.): The Point to Point Protocol, *IETF RFC 1661*, July 1994.